

Tomahawk™

A Helicopter Simulation



Datasoft®

Datasoft®

19808 Nordhoff Place, Chatsworth, CA 91311 / (818) 886-5922

FOR THE APPLE IIGS

Tomahawk™

Original Game Programmed By
D. K. Marshall

Apple II GS Translation & Enhancements By
John Brooks

Stereo Sound Effects By
John Brooks
Thomas J. Clement

Music By
Thomas J. Clement

Pilot's Handbook Written & Designed By
Thomas J. Clement
Kathi B. Somers

Pilot's Handbook Illustrations By
Thomas J. Clement

TABLE OF CONTENTS

INTRODUCING TOMAHAWK.....	1
THE APACHE POSTER INSERT.....	1
THE PILOT'S HANDBOOK.....	1
REQUIREMENTS.....	1
LOADING.....	1
GAMEPLAY CONTROLS.....	2
JOYSTICK.....	2
KEYBOARD.....	2
SET-UP WINDOW.....	2
OPTIONS WINDOW.....	3
DAY OR NIGHT.....	3
CLEAR/CLOUDY.....	3
CLOUD BASE.....	3
MISSION NUMBER.....	3
SOUND.....	5
CROSSWINDS AND TURBULENCE.....	5
PILOT RATING.....	5
COMMENCE MISSION.....	5
INSTRUMENT PANEL.....	5
WARNING LIGHTS.....	6
Temperature.....	6
Fuel.....	6
Rotor.....	6
Engines.....	6
Weapons.....	6
Speed.....	6
Nearing Enemy Helicopters.....	6
Structural Hits Taken.....	6
Navigation Computer.....	6
Target Acquisition & Designation System.....	7
SCORE.....	7
PAUSE.....	7
MAP.....	7
FLIGHT CONTROLS.....	8
Torque %.....	8
RPM %.....	8
Collective Lever.....	9
Throttle Lever.....	9
TADS.....	9
Pilot's Visual Display.....	9
Altitude.....	9

Speed.....	9
VSI (Vertical Speed Indicator).....	9
ETA (Estimated Time of Arrival).....	9
Artificial Horizon.....	13
Helicopter Roll Symbol.....	13
Degree of Roll.....	13
Direction of Roll.....	13
Up/Down Pitch.....	13
Sideslip (Drift) Indicator.....	13
Objective Radar Modes.....	13
Beacon Radar.....	13
Helipad Guidance.....	13
Ground Target Tracking.....	14
Enemy Helicopter Radar.....	14
Target (Objective) Selector.....	14
Objective (Radar) Navigation/Compass.....	14
Heading.....	14
Track.....	14
Bearing.....	15
Range.....	15
Rudder.....	15
Temperature Gauge.....	15
Fuel Level.....	15
Weapons.....	15
30mm Chain Gun.....	16
Rockets.....	16
Hellfire Missiles.....	16
Sights.....	16
MISSION COMPLETION.....	16
3D REAL-WORLD DISPLAY.....	17
FLYING TOMAHAWK.....	18
GETTING OFF THE GROUND.....	18
FLYING FORWARD FROM A HOVER.....	18
TURNING.....	19
BACKWARD & SIDEWAYS FLIGHT.....	19
TORQUE TURN.....	20
AEROBATICS.....	20
AUTOROTATION.....	20
Engines On Landings.....	21
Engines Off Landings.....	21
SLOWING DOWN & RETURNING TO A HOVER.....	21
LANDING.....	22
From Hover.....	22
Rolling Touchdown.....	22
GLOSSARY.....	23

INTRODUCING TOMAHAWK

The Tomahawk (the US Army's AH-64A Apache, Advanced Attack Helicopter) was designed to be the deadliest chopper in the sky. And it has just one purpose: seek and destroy aircraft, tanks, artillery, — anything unlucky enough to stand in its way. The Tomahawk's impressive array of weapons and unmatched maneuverability make it the toughest air-war fighter going!

THE APACHE POSTER INSERT

Included in your package is a colorful poster detailing the "History, Design, and Development" of the US Army's AH-64A Apache. The poster graphically shows an Apache recognition chart; a cut-away of the Apache's construction; and step-by-step examples of famous flying maneuvers (eg, the High Yo Yo and the Wing Over Attack). The poster also explains the theory of helicopter piloting and gives several vital flying tips that aren't found in the Pilot's Handbook. If you want to spend more time in the air than crashing into the ground, we recommend you read the poster at least once before taking to the skies.

THE PILOT'S HANDBOOK

The Pilot's Handbook is what you're reading right now. It explains how to get started playing Tomahawk and how to use the various game-play options; how to understand and use your instruments and weapons; and, rather importantly, how to fly (detailed in the back of the Handbook). A glossary of terms is found in the back of the Handbook, too. It's a good idea to take the Handbook with you on your first few missions so you can refer to it in those spare moments when you aren't involved in some life-or-death aerial dog fight.

REQUIREMENTS

- Apple® II GS computer (512K)
- Video monitor or TV
- Apple 3.5" disk drive
- Joystick (recommended)
- Stereo headphones or speakers (optional)
- Supersonic or Future Sound stereocards (optional)
- Aviator's Glasses and Pilot's License (recommended)

LOADING

1. Turn off the computer and connect a Joystick.
2. Turn on your monitor or TV.
3. Insert TOMAHAWK disk into drive. Turn on the computer.

GAMEPLAY CONTROLS

You can play Tomahawk using a Joystick or your Keyboard. To toggle between the Keyboard and the Joystick, press **K**.

Joystick

To fly your chopper using the Joystick, follow the commands below.

Bank Left — Joystick **LEFT** Climb Up — Pull **BACK** on Joystick
 Bank Right — Joystick **RIGHT** Dive Down — Push **FORWARD** on Joystick

Keyboard

If you choose to play using the Keyboard, you'll have to make a change on the GS Control Panel. Under the Options Menu, set Repeat Delay all the way to the left and Repeat Speed all the way to the right. This gives maximum flying responsiveness.

Note: A template of Keyboard commands is shown on page 12 of this manual.

SET-UP WINDOW

When TOMAHAWK loads, a screen appears showing several selections.

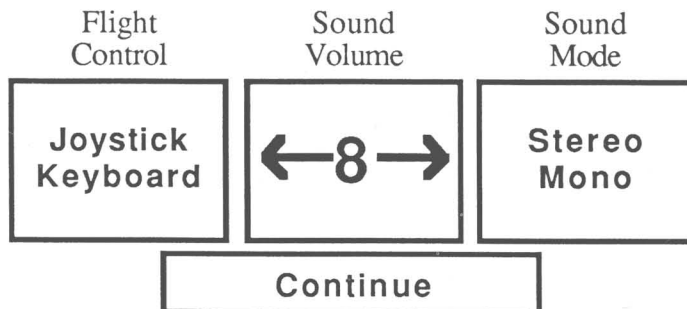

Use the Mouse to move the Selection Arrow to any option. Click the Mouse Button to select (eg, click on Stereo to select the Stereo Sound Mode). Red indicates selected; green indicates deselected.

To change the Sound Volume (middle box), click on the left or right arrows to adjust volume down or up between 1 and 8.

Note: You must have a stereo card installed to hear the game in stereo (the card turns off the GS's internal speaker). Click Mono if you want to hear out of the internal speaker or want to use the GS's headphone jack to connect headphones (mono).

When you're finished making your choices, click Continue.

OPTIONS WINDOW

Use the Mouse to move the Selection Arrow to any option. Click the Mouse Button to select an option (red indicates selected; green indicates deselected). Once you've made your choices, move the Selection Arrow to

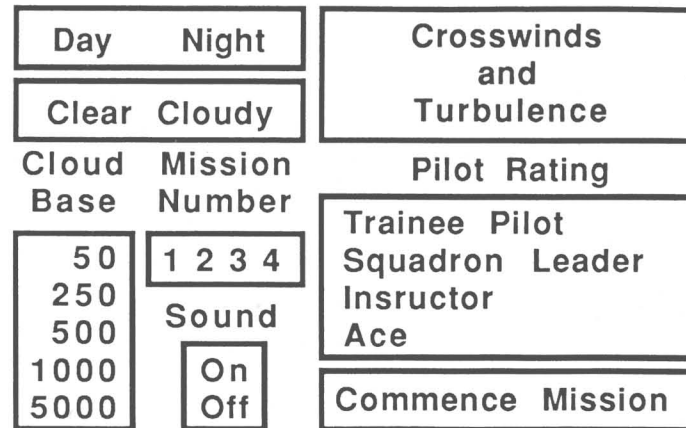

Commence Mission and click the Mouse Button.

Day or Night

Select Day and the horizon is visible when you're in the air. Select Night and you'll no longer see the horizon (the Computer-Enhanced Infrared system auto-matically makes objects visible).

Clear/Cloudy

This gives the option of clear weather or an overcast sky with a selectable Cloud Base for instrument flying.

Cloud Base

You can choose a Cloud Base as low as 50 and as high as 5000 feet. The Cloud Base affects your ability to fly (you'll have to rely on instruments) and attack the enemy: the lower the clouds, the greater the challenge.

Mission Number

There are four missions, one for Flight Training which allows you to learn how to fly without being shot down, and three successively difficult Combat Missions. The Missions will be described shortly; but first, a word about the Map.

The battle area is a Map divided into 8 rows of 16 sectors. Each sector contains up to 8 enemy Targets (field guns or tanks) giving a total of 1024 Targets across the Map (a visual display of this Map is available during your flight). You can tell if a Target is foe or friend by looking at the TADS. If the Target icon is Red, attack with confidence; if it's Blue, it's a buddy; don't accidentally hit it!

Note: Throughout this manual, you'll see the words Target and Objective. A Target, as you might expect, is something you want to attack. An Objective is something you want to fly toward, but not necessarily obliterate when you get there, like your own Helipads or Radar Beacons.

- 1 Flight Training** — This Option gives all the excitement of honing your flight and ground-attack skills without the deadly annoyances of enemy ground fire or hostile aircraft (you still have to deal with "Pilot Error," however, so training missions aren't pieces of cake!).
- 2 Combat** — This short mission involves the invasion of four Allied sectors by enemy ground forces. Select the Map Mode (press **M**), to see the Allied sectors (they flash to indicate the presence of hostile forces). Your mission is to liberate the four sectors by destroying the ground Targets (it takes about 10 minutes to clear each sector). After destroying all Targets, complete the mission by landing at the nearest helicopter pad and closing the throttle.
- 3 Combat** — Your mission is to liberate the entire Map from hostile occupation. Each enemy sector becomes Allied as the ground Targets are cleared, allowing you to land at a Helipad for ammo, repairs, and fuel.
- 4 Combat** — This is a strategic battle for occupation of the entire Map. Your task is to support Allied ground forces in their battle along the front line. As each sector is cleared of enemy ground forces, the front line progresses to the right until you have cleared a complete row of sectors.

If the enemy succeeds in destroying your ground forces, the sector becomes hostile territory and the front line progresses to the left. Once a row is completely liberated or occupied, it's out of the game.

Note: In all Combat missions, the enemy tries to blow you out of the sky! The quickest defense is to use your laser-guided Hellfire Missiles to destroy an opponent (points scored with Missiles are lower than if Rockets or the Chain Gun are used). If you do lose a chopper, you still have 2 more at home base to fall back on.

In the heat of battle, take care not to land in enemy territory if you're damaged or in need of fuel or ammo. Check for enemy occupation before landing by inspecting the Map (see page 7).

Sound

Click on the selections in this box to turn the sound effects OFF and ON.

Crosswinds and Turbulence

If you pick "Crosswinds and Turbulence," you'll see a Meterological Report. This report shows the kinds of wind conditions you'll have to contend with (novice pilots might be wise to fly a few missions without selecting "Crosswinds and Turbulence").

Meterological Report
219 degrees at 19 knots
Continue

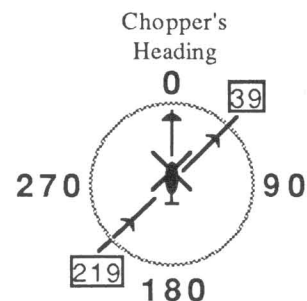

Here's how the Crosswinds affect flight. If a Crosswind is hitting your craft at 219 degrees, you'll be pushed 39 degrees in the opposite direction ($219 - 180 = 39$). The speed at which you're pushed is roughly 19 knots, give or take.

Click "Continue" to proceed.

Pilot Rating

This sets the difficulty level of the mission based on what you say your abilities are (if you claim you're an Ace, the computer treats you accordingly and things will be rough!). With each increase in pilot rating, the enemy's accuracy doubles!

Commence Mission

This puts you in the pilot seat, ready to fly. . . . or die.

INSTRUMENT PANEL

Keep careful tabs on your chopper's condition at all times. This means constantly scanning the Instrument Panel, especially the warning lights. It will take some practice to coordinate reading the Instrument panel, clicking on flight and fight selections, and avoiding enemy fire.

The words "Please don't let me Crash and Burn" will constantly be on your lips until you learn the art of staying airborne. Before taking your bird into the wild blue, however, why not look over the Instrument Panel now. Each function is described in detail and there's a two page diagram of the controls in the center of this Handbook. Refer to it as you read the following material.

Warning Lights

Warning Lights hint that all may not be well for your flying future; that's why they're prominently placed at the top of the Instrument Panel: 5 lights on the left; 5 on the right. Don't ignore them. If any Warning Light signals distress, find a friendly Helipad base ASAP to get repaired, refueled, or refitted.

TEMP **TEMPERATURE** If you demand too much from your engines, they overheat. Not good. An Orange light means you're pushing things. If you ignore this, the engines eventually cough oil and die.

FUEL **FUEL** When fuel drops to 25% of capacity, the light turns Yellow (time to tank up); Orange means you're down to 10%; and Red shows you're Empty.

ROTOR **ROTOR** If the Rotor warning light goes red, you've ripped off a rotor and will begin your violent descent to Earth (OK, so it's not much of a "warning").

ENG **ENGINES** If you lose an engine, you'll see an Orange light (you'll also hear the engine cut out and notice the speed drop). Lose another engine and the light turns Red (you're about to descend alarmingly fast unless you immediately drop your Collective to nothing—a very difficult thing to do).

WEAP **WEAPONS** If one weapon is knocked out, the light glows Orange. Red means you've lost two weapons. The Chain Gun can't be wiped out, so this warning light only applies to Rockets and Missiles.

SPEED **SPEED** When you reach 180 knots, you'll see a Yellow light; 190 knots, an Orange light; 200 knots, a Red light. The chopper sheds a rotor blade at 211 knots!

HELI **NEARING ENEMY HELICOPTERS** This Orange light warns of the approach of an unfriendly chopper. Stand by for action.

SHOT **STRUCTURAL HITS TAKEN** Your craft is very sturdy, but it can only survive so many major strikes from enemy weapons. During combat, enemy fire is indicated by flak. Warning Lights will tell if you've been hit. A Yellow light means one hit (find a Helipad and get repaired); an Orange light means two; and a Red light means you're ashes.

NAV **NAVIGATION COMPUTER** You're in instant trouble when the Navigation Computer is blown out. The Red light means return to base now (though you'll have trouble finding the way).

TADS **TARGET ACQUISITION & DESIGNATION SYSTEM** Without TADS, you can't decide who is friend or who is foe—until it's too late. The Red light means you can't effectively use your weapons.

Score

0000 This window shows how you're doing. There are three things you can destroy: field guns, tanks, and helicopters. *How* you destroy them (Chain Gun, Rockets, or Missiles) affects your score. If you knock out a helicopter with a Hellfire Missile (easy hunting), you only get 25 points., but if you scratch it with a Chain Gun (major marksmanship), you're awarded 100! The accumulation of all points is shown in the Score window. The breakdown below is shown at the end of the game on the Mission Report Screen.

Weapon Used	Target		
	Field Gun	Tank	Helicopter
Chain Gun	20	—	100
Rockets	10	20	50
Missiles	05	10	25

If you destroy Allied forces, you lose all your points (Allied forces are blue, enemy forces are red).

Pause

P The game can be paused and unpaused at any time (click the Pause icon or press **ESC**).

Map

M The Map is very handy (click the Map icon or press **M**); it shows the separation between Allied and hostile territories (light blue and orange areas, respectively); mountain ranges (jagged icons); Radar Beacons (the white numerals show their positions); and your blue helicopter and the enemy's red helicopter. If the blue area flashes, it's being invaded; if the orange area flashes, the enemy is being pushed back.

The Map is divided into 8 rows of 16 sectors. Each sector contains up to eight enemy Targets, field guns or tanks, giving a total of 1024 Targets across the Map.

You are represented by a blue helicopter; the enemy by a red one. After destroying all Targets in one sector, proceed to the adjacent sector. Refuel and reload with ammo as necessary.

Note: The fastest way to get from sector to sector is by using Rapid mode (press **R**).

You can move from one sector to another *without* having to fly there. Here's how. Land on an Allied Helipad; select the Map Mode; then use the Joystick to move to another sector.

Note: You can't use this method to move to another Helipad in the *same* sector or to enter enemy territory. You have to be flying to do that.

There are 8 Beacons for the entire Map and they're only visible when you have the Map toggled on. Use them as landmarks for long-distance navigation (you can lock onto these Beacons using the Beacon Objective radar mode). Jot down the Beacon's coordinates for navigation reference.

In **Mission 1**, all sectors are Allied; any Helipad is safe for refuelling, re-arming, and repairs. All sectors contain enemy tanks and field guns for Target practice.

In **Combat Missions (2-4)**, Allied territory is blue and enemy territory is red. A flashing blue sector means there are enemy forces in Allied territory. A flashing red sector indicates Allied forces in the enemy territory. If you touch down in a hostile sector, you'll be captured by the enemy.

The destruction of all enemy forces in a red sector results in the sector becoming Allied. If all Allied forces in a blue sector are destroyed, that territory becomes hostile.

Flight Controls

At first, the Tomahawk's Instrument Panel may look daunting, but you'll soon get used to it. For tips on how to use these marvelous controls and read-outs in flight, consult the back of this Handbook and the Apache Poster Insert.



TORQUE % This window indicates the amount of force that's exerted on the engines to make the chopper dive, climb, etc. Torque stress is directly related to your Collective setting.



RPM % This read-out shows the Revolutions Per Minute of the engines and rotors.



COLLECTIVE LEVER The Collective is the angle of the rotor blades which, in turn, controls the lift of your craft. Use the Collective Lever to get Tomahawk off the ground and to hover (click in the Collective indicator to move the arrow; or press **A** to decrease and **S** to increase the Collective).

A zero Collective means the rotors are level—no lift. Increased Collective means increased lift. Remember, though, increase the Collective too much and you'll strain the engines.



THROTTLE LEVER The Throttle controls the amount of fuel reaching the engines; more fuel, more power. Power is described in the engine's RPM read-out. Usually, you keep the throttle wide open when flying and close it upon landing (click in the Throttle indicator to move the arrow; or press **D** and **F** to decrease or increase the Throttle).



TADS The Target Acquisition & Designation System (TADS) is used to identify and track enemy and Allied tanks, field guns, and helicopters. When you have a Target in the center of your Weapon's sight, that Target appears in the upper part of the TADS display (the Target is red if it's an enemy; blue if it isn't). If the range is under 10,000 feet, the exact range will appear in the lower part of the TADS window. When the Target is farther than 10,000 feet, this window is blank.

Altitude	0000
Speed	→ 0000
VSI	↑ 0000
ETA	00:00

PILOT'S VISUAL DISPLAY The Pilot's Visual Display gives vital information about altitude, speed, and approximately how long it will take to reach the Target shown in TADS.

Altitude This shows how far you are away from the ground. This altitude is in feet.

Speed This window indicates your forward (⇒) or backward (⇐) speed.

vsi (Vertical Speed Indicator) This shows your speed (in feet per second) when climbing (↑) or diving (↓).

ETA (Estimated Time of Arrival) This tells how long it will take you to reach the Objective, based on your current speed. The time is shown in hours and minutes.

TEMP Temperature
 FUEL Fuel
 ROTOR Rotor
 ENG Engine
 WEAP Weapons

Speed SPEED
 Nearing Enemy Chopper HELI
 Structural Hits Taken SHOT
 Navigation Computer NAV
 TADS TADS

0000 Score

Pause **P**
 Map **M**

Engine Torque
 RPM
 1 R 2
 engine engine

Range Per TADS
 TADS
 Altitude 0000
 Speed → 0000
 VSI ↑ 0000
 ETA 00:00

Up/Down Pitch
 Degree Of Roll
 Roll
 Sky
 Land
 000 Right



Rudder
 Target
 7

Target Heading
 Fuel
 Target Track
 Target Bearing
 Range

Collective C
 Throttle T
 8 38 1200

Direction Side Of Roll Slip

Hellfire Missiles →
 Rockets →
 Chain Gun

Enemy Helicopter 
 Helipad **H**
 Beacon 
 Ground Target 

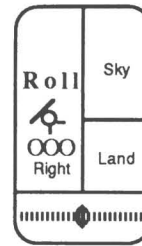
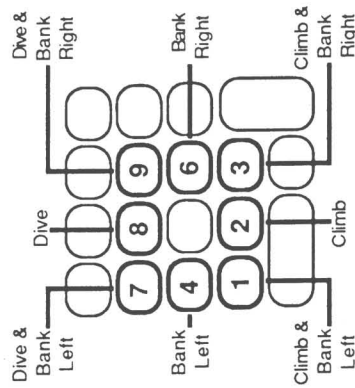
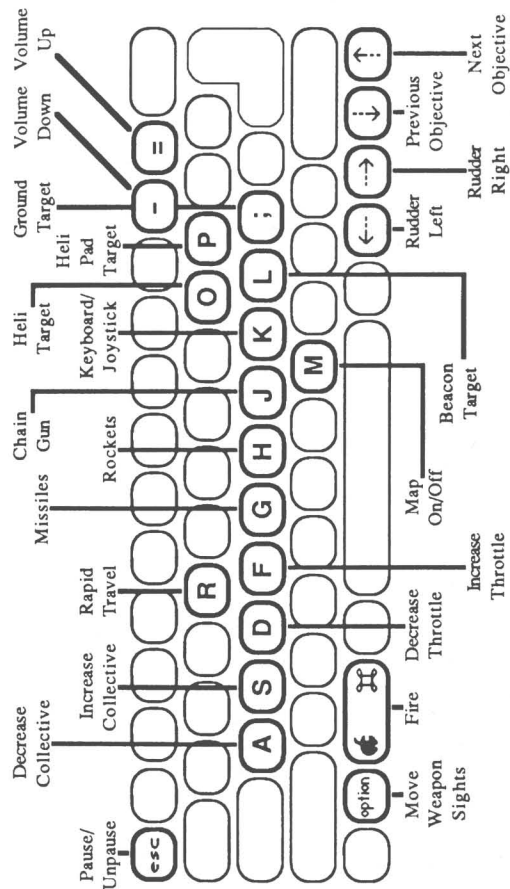

ARTIFICIAL HORIZON This shows you a graphic representation of the helicopter's position in relation to the ground.

Helicopter Roll Symbol This gives a visual image of the helicopter's angle in relation to the ground.

Degree of Roll This shows, numerically, the chopper's angle in relation to the ground (read-out is directly under the Helicopter Roll Symbol).

Direction of Roll This indicates whether the chopper's roll is stable or to the left or right.

Up/Down Pitch This shows how steeply you're climbing or diving (sky and land). A numeric read-out on the side of this Pitch display shows to what degree you're pointing the chopper's nose up or down.

Sideslip (Drift) Indicator This indicates how much the helicopter "slips" left or right. This slipping usually occurs when hovering or when flying slower than 60 mph. This indicator should stay right in the middle; if it shows you're slipping left or right, it means you're losing altitude!

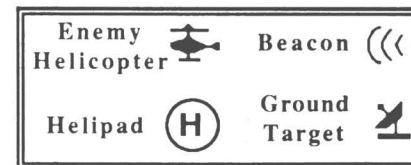



OBJECTIVE RADAR MODES This shows what radar Objective you're tracking to: Beacon, Helipad, Ground Target, or Enemy Helicopter.



The range from each Objective is shown under the Objective (Radar) Navigation read-out. The ETA is given in the Pilot's Visual Display.



Beacon Radar lets you "lock on" to Beacon Towers so you can use them for guidance. There are 8 Beacons on the Map, 0-7, and they're only visible when the Map is toggled On. Use Beacons as landmarks for long-distance navigation by jotting down the Beacon's coordinates for future reference (click the Beacon radar icon or press L).

Helipad Guidance lets you find the closest landing area. There are four Allied Helipads per sector, 0-3. If you happen to set down on an enemy Helipad, you won't like what develops (click the Helipad radar icon or press P).

 **Ground Target Tracking** lets you home in on enemy ground Objectives. There are 8 Targets per sector, Ø-7, half of which are tanks; the other half artillery (click the Ground Target radar icon or press ;).

 **Enemy Helicopter Radar** allows you to locate an enemy chopper. Only one Enemy Helicopter is found on the Map at any one time (click the Enemy Helicopter radar icon or press O).

  **TARGET (OBJECTIVE) SELECTOR** Once you've chosen an option from the Objective Radar Mode (Beacon, Helipad, Ground Target, or Enemy Helicopter), use the Target (Objective) Selector, to pick *which* Target or Objective you wish to fly toward (click the left or right arrows in the Target control or press ↑ or ↓).

Target
← 7 →

For example, you need to locate the nearest Helipad so you can land and resupply your craft. Click on the Helipad icon from the Objective Radar Mode, then use the left and right arrows in the Target (Objective) Selector to scroll through the Helipads in your sector (Ø-3).

As you scroll, notice the Bearing and Range in the Objective (Radar) Navigation display change to show your proximity to that Objective or Target.

 **OBJECTIVE (RADAR) NAVIGATION/COMPASS** This gives you readouts of the helicopter's Heading, Bearing, and Track.

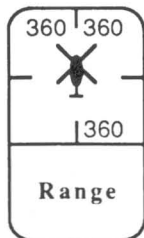
A helicopter can be pointing in one direction (Heading) but flying in another (Track). This is because a chopper can fly sideways and backwards as well as forward.

The flashing dot shows the relative Bearing of the Objective. Here's how to fly toward that Objective. Change your Heading to your Objective's Bearing (turn toward the flashing dot). After the Heading and Objective Bearing are matched, the Track will follow the Heading automatically, which means you're now heading and pointing in the right direction.

Heading This shows which direction the helicopter is pointing (number in upper-left of window).

Track This shows the direction you're actually flying in (number in upper-right of window).

Bearing This shows where the Objective is (number in lower-right of window).

Range This constantly updates you on the distance from the Objective:

Within 0.1 miles—readout is in feet
Within 4.9 miles—readout is in tenths of a mile
Over 5 miles—readout is in miles

If the selected Target has already been destroyed, this display is blank.

Note: Crosswinds also affect your navigation. For example, if you are flying North (Heading: 0 degrees) and encounter a 270-degree crosswind, your Track shows at 30 degrees NE. So, even though the chopper is pointing (Heading) at 0 degrees N, it's actually flying at 30 degrees NE. You'll need to adjust these to fly in the direction of your Objective (Bearing).

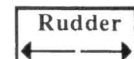
 **RUDDER** The rudder is only useful for turning when you're traveling at less than 60 mph. Above that, wind resistance makes the rudder useless (click the arrows in the Rudder control or press ← or → on the Keyboard).

 **TEMPERATURE GAUGE** This indicator lets you know how hot the engines are getting. If the engines overheat, they'll die.

 **FUEL LEVEL** This indicator shows how much fuel is in reserve. To refuel, find a Helipad and touchdown. The chopper will immediately be serviced and prepared for takeoff. Follow this same procedure when you need repairs or more ammunition.

 **WEAPONS** There are three weapons in your arsenal: Chain Gun, Rocket Launcher, and Hellfire Missile Launcher. The weapon in use is Yellow; inoperative weapons are Red.

Note: Your helicopter must be in the air before you can fire at a foe. Use the Joystick Fire Button or Open Apple to shoot.

When using the Chain Gun or Rockets, the Target must be visible in your sights before you fire. Hellfire Missiles actually "lock on" to any hostile Target passing through your sight. Once the Missile is locked on, tracking is automatic as long as the Target remains on-screen.

Note: A good strategy for lower-skilled pilots is to attack with Hellfire Missiles Since the Missiles are laser guided, you don't have to be a marksman to hit anything.



30mm Chain Gun The Chain Gun is a 30mm, automatic cannon aimed via a rotating turret. The Chain Gun has a range of 2,000 feet, holds 1200 shells, and possesses a firing rate of 750 rounds-per-minute. Every 4th round is a tracer. These let you see if the shells are on Target (click the Chain Gun icon or press J).



Rockets Your chopper features 38, 70mm Rockets (19 per side). These Rockets are unguided and have a service range of 4,000 feet (click the Rocket icon or press H).



Hellfire Missiles For the ultimate in tank-busting, you can rely on your 8 laser-guided, auto-tracking Hellfire Missiles. These are the most accurate weapons you have, and though they're most often used against armour, they are just as formidable against other Targets (click the Missile icon or press G).

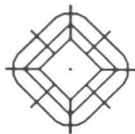

Chain Guns

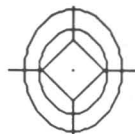

Rockets

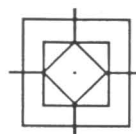

HellFire Missiles

SIGHTS
Each weapon has its own sight. When TADS

starts tracking a Target, the sensors automatically change the sight to red. When the Target is in view, start shooting!

To move the sight via the Keyboard, hold down the **OPTION** key and use the arrow keys.

MISSION COMPLETION

There are two ways to complete a Mission: successfully. . . and the other way. To be successful, you must destroy all enemy ground forces and return safely to an Allied Helipad. After touchdown, close the Throttle to bring the engine and rotor RPM to zero. A Mission Report follows.

Tomhawk Mission Report

Mission Successful

Helicopters at Base: 2

Destroyed	Allied	Enemy
Tanks	○	○
Field Guns	○	○
Helicopters	○	○

Continue

Hopefully you'll find the "Mission Successful" salute in the Mission Report. Sadly, however, you'll probably be confronted with something else your first few times up, "Helicopter Destroyed"!

There are several ways to destroy your helicopter. You'll be told specifically how you achieved this loss every time you trash your craft (some are more embarrassing than others):

- | | |
|----------------------------|-----------------------------|
| Collided with a: Field Gun | Collided with a: Tank |
| Collided with a: Tree | Collided with a: Mountain |
| Collided with a: Pylon | Collided with a: Helicopter |
| Collided with a: Building | Descent rate too high |
| Touchdown was not level | Landing speed exceeded |
| Landing sideslip exceeded | Shot down by enemy |
| Captured by enemy | Rotor Blade Lost |
| Fuel depleted | |

3D REAL-WORLD DISPLAY

The 3D terrain you fly over features buildings, Helipads, transmission pylons, trees, mountains, enemy tanks, field guns, and helicopters. Fly below 500 feet and the texture of the ground becomes visible.

Though it's possible to fly between trees and mountains, it takes a bit of practice (and not a few mangled Tomahawks).

FLYING TOMAHAWK

Helicopters are naturally unstable and difficult to fly without Autostabilization. The Tomahawk is fitted with Digital Automatic Stabilization Equipment (DASE), making it far easier to fly than most modern choppers.

Getting Off the Ground

The following are step-by-step instructions for getting your Tomahawk into the air.

- 1 Make sure the Collective indicator is at the minimum setting (click on and move the arrow in the Collective indicator or press **A** to decrease the Collective).
- 2 Make sure the Throttle indicator is at maximum setting (click on and move the arrow in the Throttle indicator or press **F** to increase the Throttle).
- 3 Wait for engine RPM and rotor RPM to reach 100%.
- 4 Increase the Collective until lift-off occurs; the Pilot's Visual Display shows vertical speed in feet per second (VSI).
- 5 Now, decrease the Collective until the VSI shows \emptyset (you're not climbing or descending); the chopper is now hovering above the Helipad.
- 6 Use the rudder to turn on the spot (click the arrows in the Rudder control or press \leftarrow or \rightarrow on the Keyboard).

Flying Forward from a Hover

Now that you're in the air, it's time to learn how to use Tomahawk as transportation. This is an extremely agile chopper; from a stable hover you can reach 100 knots in about six seconds by pulling 100% Torque and tilting the nose down to approximately 30 degrees.

- 1 Increase the Collective to between 80% and 100% Torque. If your engines overheat, reduce the Collective (click on and move the arrow in the Collective indicator or press **A** and **S** to decrease or increase the Collective).
- 2 Tilt the chopper's nose down (Joystick FORWARD or **8** on the Keypad) to between 15 and 30 degrees. Speed increases and autostabilizers slowly raise the nose of the helicopter to level flight. The Up & Down Pitch Indicator on the Artificial Horizon shows if the nose is down.
- 3 Reduce Collective until VSI is \emptyset .

Forward speed is related primarily to the Torque setting and, hence, the Collective Lever setting. Typical Torque/speed settings are:

Torque	Speed
044%	60 knots
060%	119 knots
075%	147 knots
100%	165 knots

These values vary with altitude and changes in the chopper's weight resulting from fuel and ammo consumption. The Tomahawk's computer-controlled stabilizer automatically lets the helicopter cruise at any speed when the fuselage is level.

Turning

If you're hovering or flying at less than 60 knots, you can simply use the rudder (click the arrows in the Rudder control or press \leftarrow or \rightarrow on the Keyboard). At speeds under 60 knots, the helicopter tends to drift into the turn (see the Sideslip indicator on the Artificial Horizon). You can adjust this by using the rudder, but it reduces forward speed.

If your speed is 60 knots or faster, the rudder is useless so you'll need to "bank" to turn (use the Joystick or the number Keypad to bank). Some vertical lift is lost when turning and the chopper will start to descend; correct this by increasing the Collective (click on and move the arrow in the Collective indicator or press **S** to increase the Collective). The helicopter tends to slow down in a turn unless the pilot compensates by diving (sacrificing height to maintain speed).

Fluctuations in rotor RPM occur during a turn because of gravitational force effects. An Autothrottle automatically adjusts the engine RPM accordingly to keep the rotor RPM at approximately 100%.

Backward & Sideways Flight

Starting from a hover, fly backwards by increasing the Collective and raising the nose to approximately 10 degrees. Keep the nose up to sustain speed (use the Joystick or press **2** to bring the nose up; click on and move the arrow in the Collective indicator or press **S** to increase the Collective).

Fly sideways by rolling left or right and raising the Collective. The Speed readout doesn't show sideways speed. Watch the sideslip indicator to monitor sideways drift.

Torque Turn

A Torque Turn is a tight, quick turn which, while putting a strain on the engines, is a very effective maneuver.

Make sure your speed is 100 knots or more. Pull the chopper's nose up to about 70 degrees (use the Joystick or press **2** to bring the nose up). Hold this nose-up attitude until the speed drops below 60 knots.

Now turn until your Heading has changed by approximately 160 degrees (click the arrows in the Rudder control or press \leftarrow or \rightarrow on the Keyboard). Adjust your roll to zero, if necessary; then accelerate with the nose down. This will have Torque Turned the Tomahawk approximately 180 degrees.

Aerobatics

The Tomahawk may be flown safely within the following limits:

Pitch \pm 90 degrees Roll \pm 110 degrees

Loops and Rolls are NOT recommended!

Autorotation

Autorotation is equivalent to the helicopter "gliding" through the air. If both your engines fail, decrease the Collective to \emptyset ; Autorotation automatically kicks in and disengages the rotors from engine power, allowing the rotors to spin freely.

When the chopper is about 12 meters from the ground, you can increase your Collective to maximum, providing a last-moment lift which *may* keep the copter from crashing.

During Autorotation, the rotor blades are driven by airflow through the rotor disc as the helicopter descends. This reduces the power required from the engines (especially helpful if there *is* no power!) and the engine RPM is automatically reduced to maintain 100% rotor speed. The "split" between engine RPM and rotor RPM can be seen on the Instrument Panel.

Autorotation is best performed at approximately 60 knots and above 500 feet. Begin Autorotation by gently lowering the Collective (click on and move the arrow in the Collective indicator or press **A** to decrease the Collective).

Note: You can also use Autorotation to descend rapidly by purposely dropping the Collective to zero.

ENGINES ON LANDINGS

As the descent rate builds up, the automatic Throttle control reduces the engine RPM. Any fluctuations in rotor RPM are compensated for automatically by the Autothrottle. As the altitude falls to below 200 feet, increase the Collective (click on and move the arrow in the Collective indicator or press **S** to increase the Collective) to reduce the rate of descent and raise the nose of the chopper to slow down (use the Joystick or press **2** to bring the nose up). With practice, you can coordinate increasing the Collective and adjusting the pitch angle in order to slow down to hover just a few feet above the ground.

ENGINES OFF LANDINGS

If both engines fail or if you deliberately close the Throttle in flight, engine RPM reduces to zero. You must act quickly to decrease the Collective (click on and move the arrow in the Collective indicator or press **A** or **S** to decrease or increase the Collective) before the rotor blades slow down too much (CRASH!). Rotor RPM is controlled during descent by careful adjustment of the Collective; keep the chopper level and the speed between 50 and 60 knots; raise the Collective just before touchdown to bring the rate of descent to less than 12 feet per second (use the Joystick or the numeric Keypad controls to keep the chopper level).

Slowing Down & Returning to a Hover

- 1 Gently raise the chopper's nose (use the Joystick or press **2** to bring the nose up). The helicopter slows down and climbs. Maintain the nose-up attitude by repeatedly — and *gently* — pulling back on the Joystick.

Keep the VSI at approximately \emptyset by reducing the Collective to reduce the rate of climb. As the forward speed drops to below 60 knots, increase the Collective to counteract the rate at which the helicopter falls (click on and move the arrow in the Collective indicator or press **A** or **S** to decrease or increase the Collective).

Let the nose of the chopper return to level flight as the speed approaches zero (use the Joystick or the numeric Keypad controls to control the chopper).

Adjust the Collective as necessary to achieve a VSI of \emptyset . The chopper should now be in a stable hover.

- 2 Banking repeatedly left and right is another method of slowing down—as long as you aren't diving!
- 3 If the forward speed is less than 60 knots, apply the rudder to increase sideslip; this slows you down dramatically as a result of the drag force generated (click the arrows in the Rudder control or press ← or → on the Keyboard).

Landing

You can land from a hover or at forward speeds of less than 60 knots.

FROM HOVER

Lower the Collective to maintain a steady rate of descent (maximum VSI at touchdown is 8 feet per second). Ground cushion effect will be experienced at 30 feet, resulting in a reduction of the descent rate.

ROLLING TOUCHDOWN

With a forward speed of less than 60 knots, gently lower the Collective to begin descent (maximum VSI at touchdown is 12 feet per second).

GLOSSARY

Aerobatics	These are fancy flying feats and maneuvers.
Artificial Horizon	This is a display on the Instrument Panel that gives the pilot a graphic representation of the helicopter's position in relation to the ground.
Autorotation	This is a method for landing a helicopter without using engine power.
Autothrottle	This is a special feature of the Tomahawk that compensates for variables in the rotor RPM and keeps the engine RPM at 100%.
Bank	To turn by giving Tomahawk a vertical slant.
Beacon	These are landmarks located around the Map for navigation purposes.
Bearing	This is the direction the chopper should fly to reach an Objective.
Collective	A flight control that changes the torque of the rotor, thus affecting its force in lifting the chopper off the ground and keeping it in flight.
DASE	Digital Automatic Stabilization Equipment that makes the Tomahawk easier to fly than other helicopters.
Doppler	This is the specialized radar system used by the Tomahawk.
ETA	This is the Estimated Time of Arrival to the Objective.
Failure Status Panel	This is the readout on the helicopter's Instrument Panel that lets the pilot know whether all systems are in proper working order.
Fuselage	The body of an aircraft.
Heading	This is the direction the helicopter's nose is pointing.
Hover	This is the term used to describe a helicopter's situation when it is airborne but staying in one spot.

Knot	This is a rate of speed: 1 nautical mile per hour (equal to approximately 1.15 miles per hour).
Landing Pad	Also called helipads, these are the spots where the helicopter can set down.
Night Vision System	This is the Computer Enhanced Infrared Imaging system that lets the pilot "see" in the dark.
Objective	This is the helicopter's destination. It may also be its Target.
Pitch	This is the angle of the helicopter's nose in relation to the ground (climbing or diving).
Range	This is the distance from your current position to the Objective.
Roll	This is the helicopter's horizontal angle in relation to the ground (rocking back and forth).
RPM	Revolutions Per Minute.
Sideslip	This term refers to how much the helicopter drifts left or right when in straight flight.
TADS	Target Acquisition & Designation System: A system for tracking and sighting Targets that interfaces directly with the helicopter's weapons.
Target	This is an Objective which needs to be attacked (eg, a field gun).
Taxi	This is the term used when a chopper is rolling along the ground.
Torque	The rotational force exerted on turbine engines.
Track	This is the actual direction of flight (this can be different from the Heading).
VSI	Vertical Speed Indicator: A cockpit display that shows how fast the helicopter is ascending or descending. If the chopper is in level flight, the readout is zero.